





**"CONSTRUCTING WILDIFE HABITAT IN A  
WOODWORKING COURSE FOR THE ILLINOIS  
DEPARTMENT OF NATURAL RESOURCES"**

**WOOD DUCK BOX PLANS**

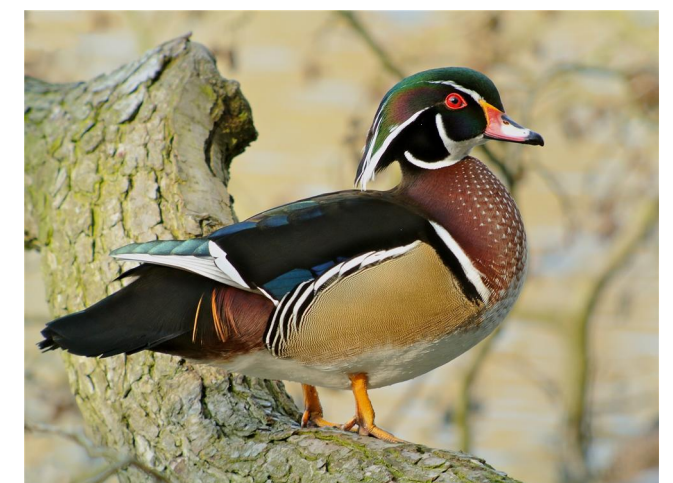

**ITEC 2016**  
Normal, Illinois  
Illinois Technology Education Conference  
Marriott Hotel & Conference Center  
Oct 28-29, 2016



			<b>TECHNOLOGY EDUCATION ASSOCIATION OF ILLINOIS</b> ITEC 2016-ILLINOIS DEPARTMENT OF NATURAL RESOURCES WILDLIFE HABITAT CONSTRUCTION SESSION	
	DESIGNED BY: Corey Duzan		PROJECT TITLE: Wood Duck Box Plans	
	9/29/2016	SHEET # 1	FILE NAME: ITEC-IDNR Wood Duck Box.iam	cduzan

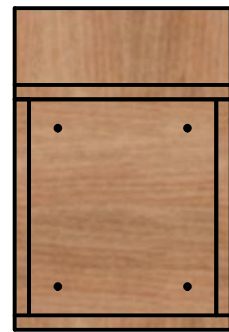
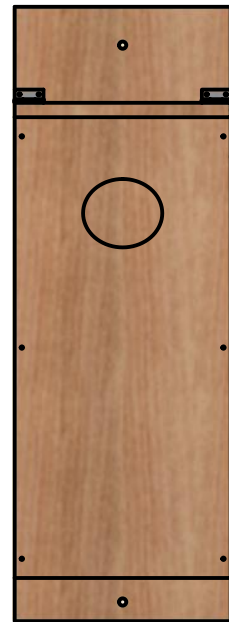
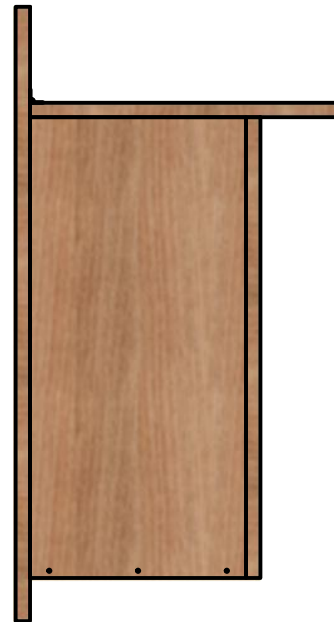

**tea***i*

**TECHNOLOGY EDUCATION ASSOCIATION OF ILLINOIS**  
ITEC 2016-ILLINOIS DEPARTMENT OF NATURAL RESOURCES  
WILDLIFE HABITAT CONSTRUCTION SESSION

DESIGNED BY: Corey Duzan

PROJECT TITLE: Wood Duck Box Plans

9/29/2016

SHEET # 2

FILE NAME: ITEC-IDNR Wood Duck Box.iam

cduzan

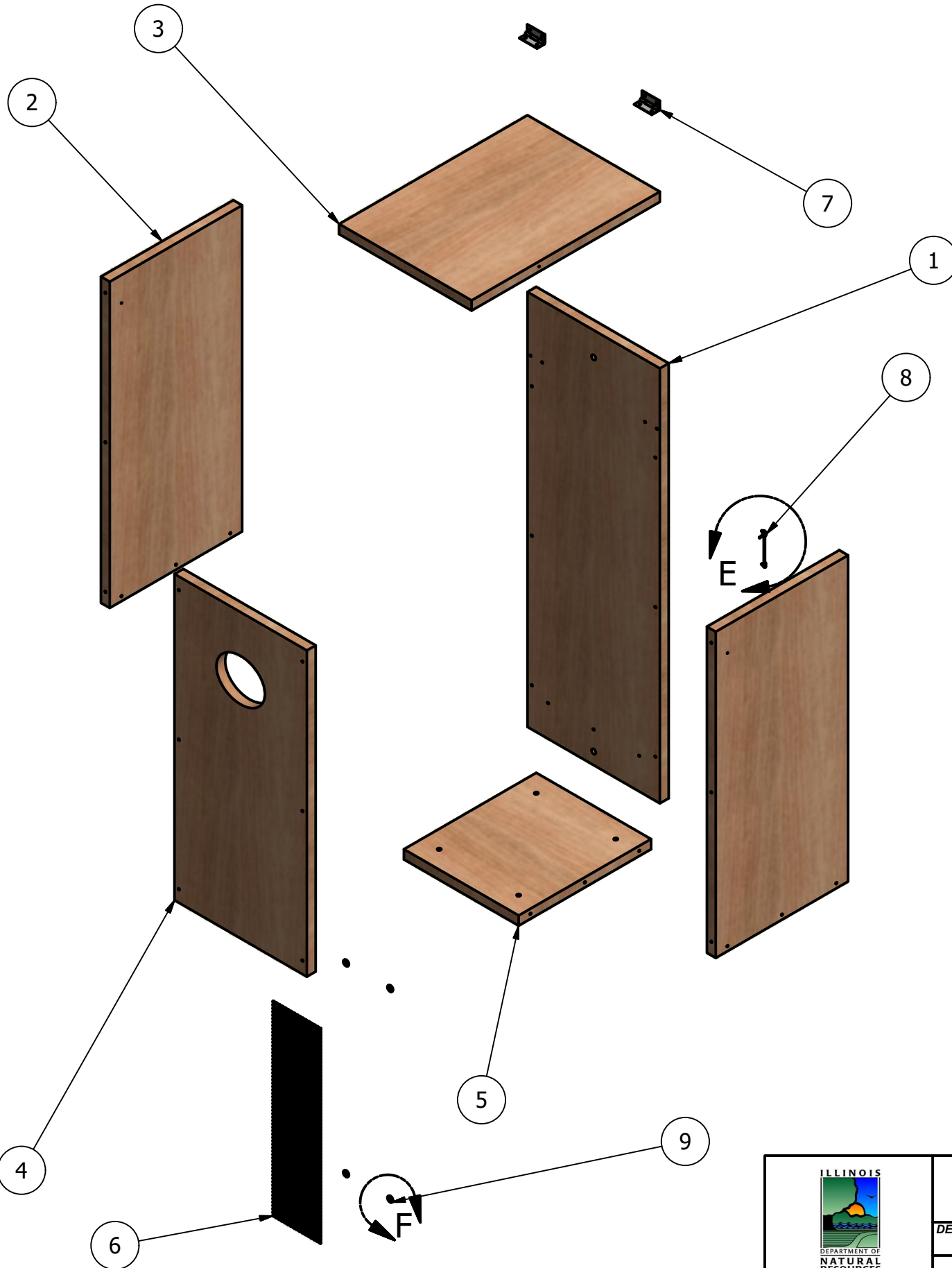

Parts List			
ITEM	QTY	FILE NAME	MATERIAL
1	1	ITEC-IDNR Wood Duck Box_Back.ipt	Pressure Treated Wood (1X12)
2	2	ITEC-IDNR Wood Duck Box_Side.ipt	Pressure Treated Wood (1X12)
3	1	ITEC-IDNR Wood Duck Box_Roof.ipt	Pressure Treated Wood (1X12)
4	1	ITEC-IDNR Wood Duck Box_Front.ipt	Pressure Treated Wood (1X12)
5	1	ITEC-IDNR Wood Duck Box_Floor.ipt	Pressure Treated Wood (1X12)
6	1	ITEC-IDNR Wood Duck Box_Hardware Cloth.ipt	Stainless Steel
7	2	ITEC-IDNR Wood Duck Box_Hinge.iam	Stainless Steel
8	1	ITEC-IDNR Wood Duck Box_Hook Eyelet.ipt	Stainless Steel
9	4	ITEC-IDNR Wood Duck Box_Washer.ipt	Stainless Steel

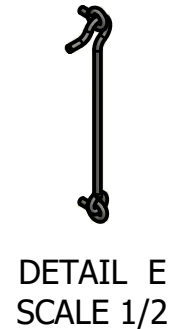



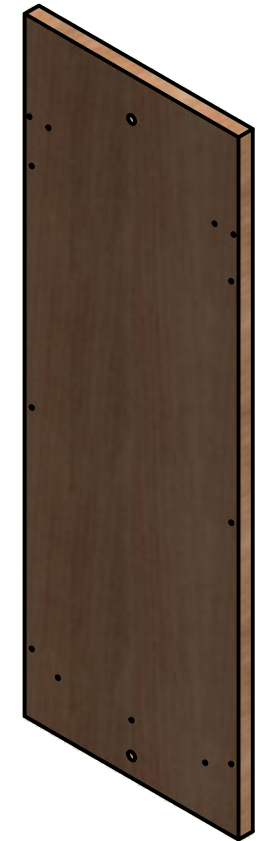
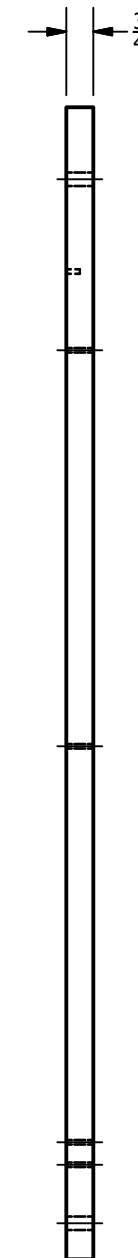
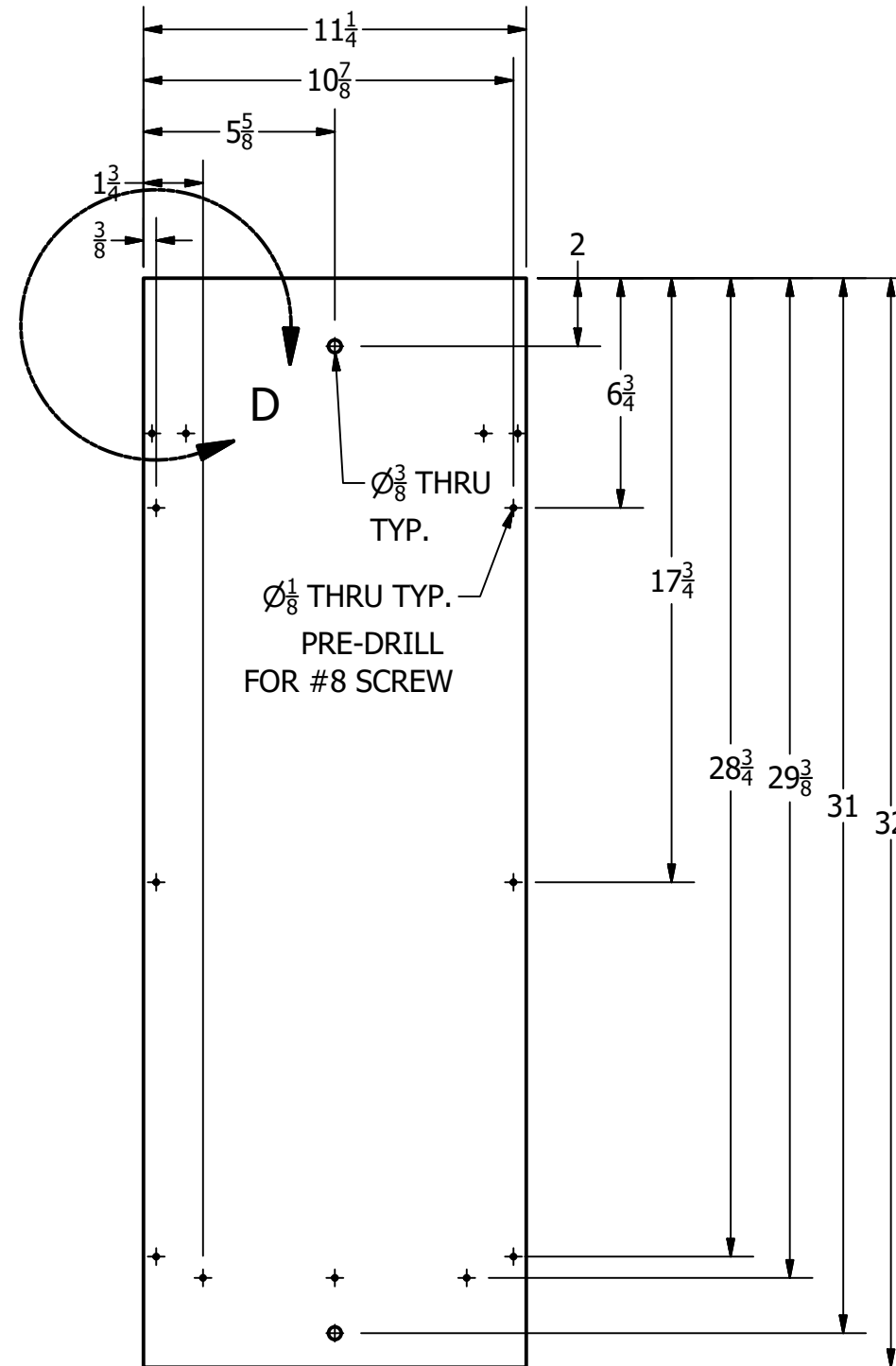
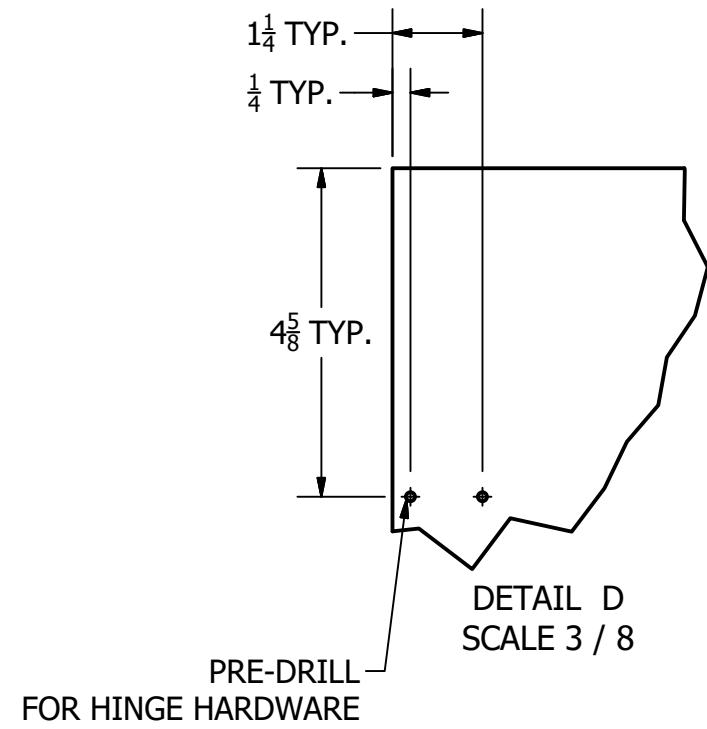

**RECOMMENDED TOOLS:**



**tea***i*

**TECHNOLOGY EDUCATION ASSOCIATION OF ILLINOIS**  
 ITEC 2016-ILLINOIS DEPARTMENT OF NATURAL RESOURCES  
 WILDLIFE HABITAT CONSTRUCTION SESSION

DESIGNED BY: Corey Duzan

PROJECT TITLE: Wood Duck Box Plans

9/29/2016

SHEET # 4

FILE NAME: ITEC-IDNR Wood Duck Box\_Back.ipt

cduzan

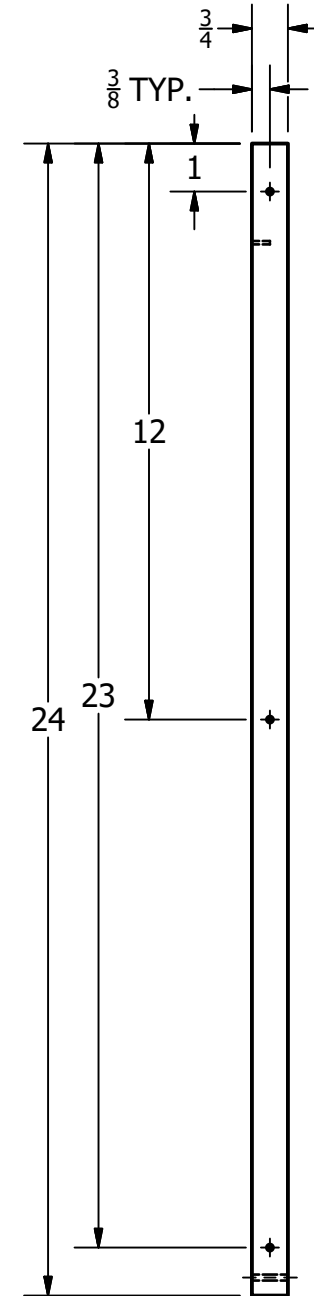
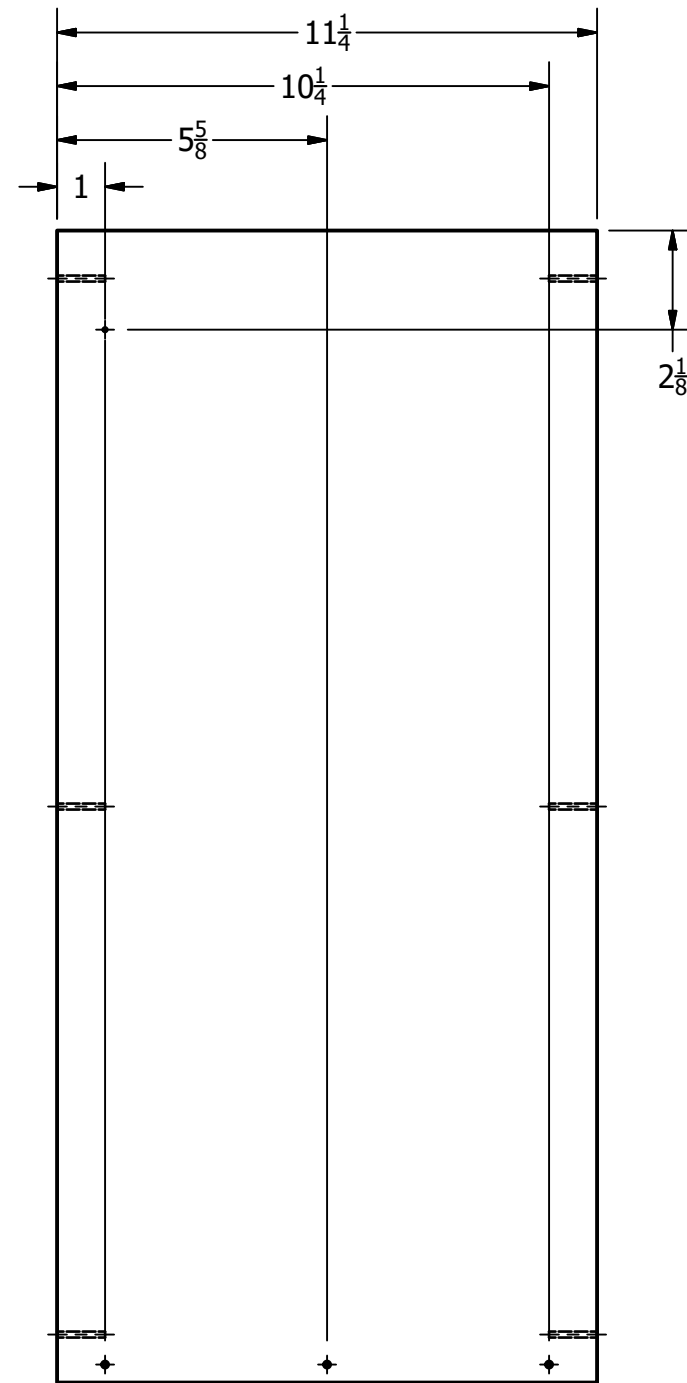

**RECOMMENDED TOOLS:**



**tea*i***

**TECHNOLOGY EDUCATION ASSOCIATION OF ILLINOIS**  
 ITEC 2016-ILLINOIS DEPARTMENT OF NATURAL RESOURCES  
 WILDLIFE HABITAT CONSTRUCTION SESSION

DESIGNED BY: Corey Duzan

PROJECT TITLE: Wood Duck Box Plans

9/29/2016

SHEET # 5

FILE NAME: ITEC-IDNR Wood Duck Box\_Side.ipt

cduzan



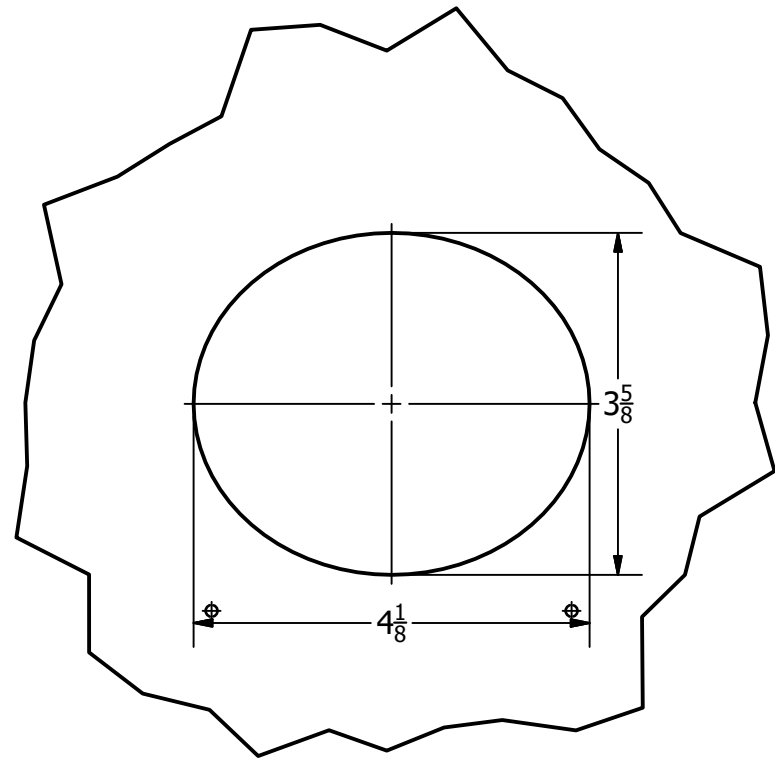

DETAIL C  
SCALE 1 / 2

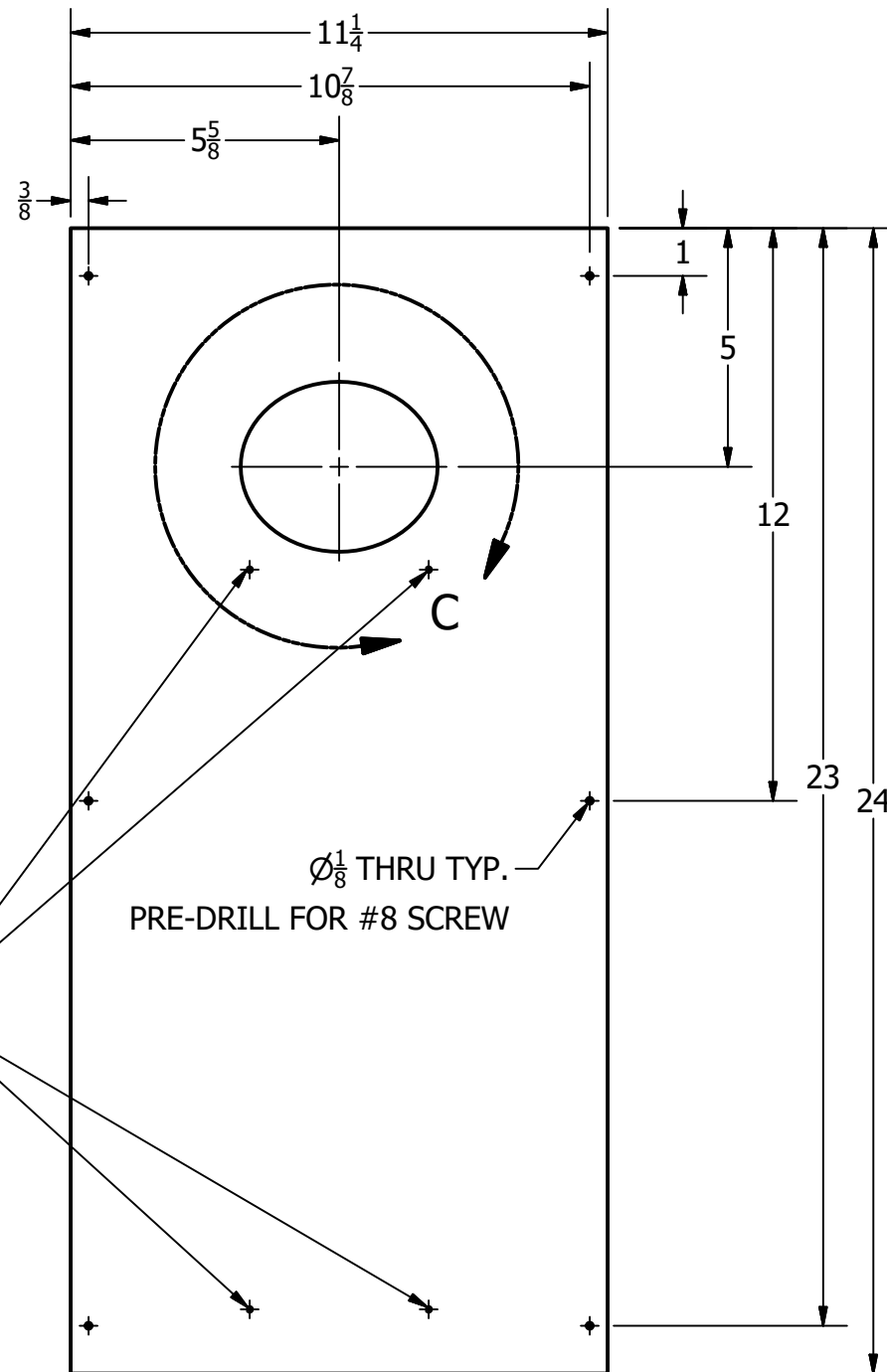

PRE-DRILL TO  
ATTACH HARDWARE CLOTH  
HARDWARE

$\text{Ø} \frac{1}{8}$  THRU TYP.  
PRE-DRILL FOR #8 SCREW

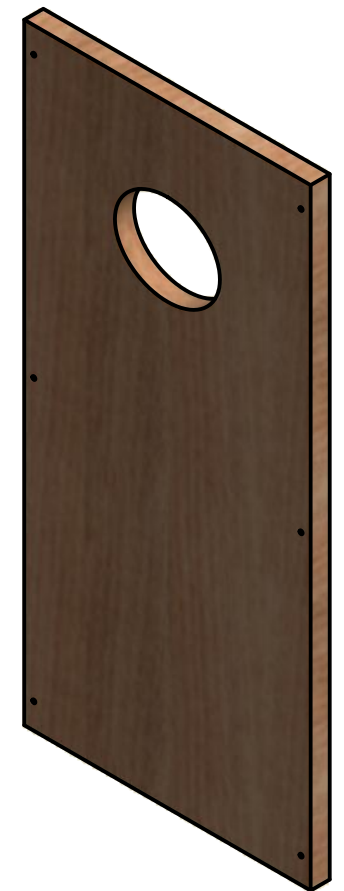
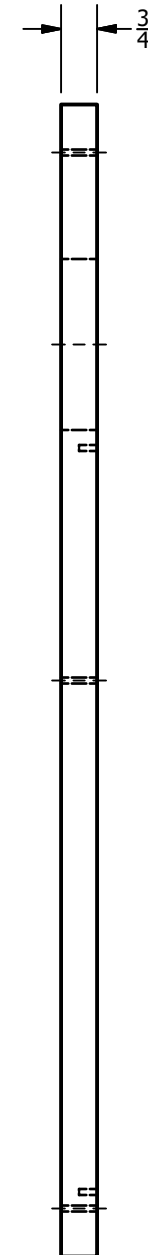

**RECOMMENDED TOOLS:**



**tea***i*

**TECHNOLOGY EDUCATION ASSOCIATION OF ILLINOIS**  
ITEC 2016-ILLINOIS DEPARTMENT OF NATURAL RESOURCES  
WILDLIFE HABITAT CONSTRUCTION SESSION

DESIGNED BY: Corey Duzan

PROJECT TITLE: Wood Duck Box Plans

9/29/2016

SHEET # 7

FILE NAME: ITEC-IDNR Wood Duck Box\_Front.ipt

cduzan

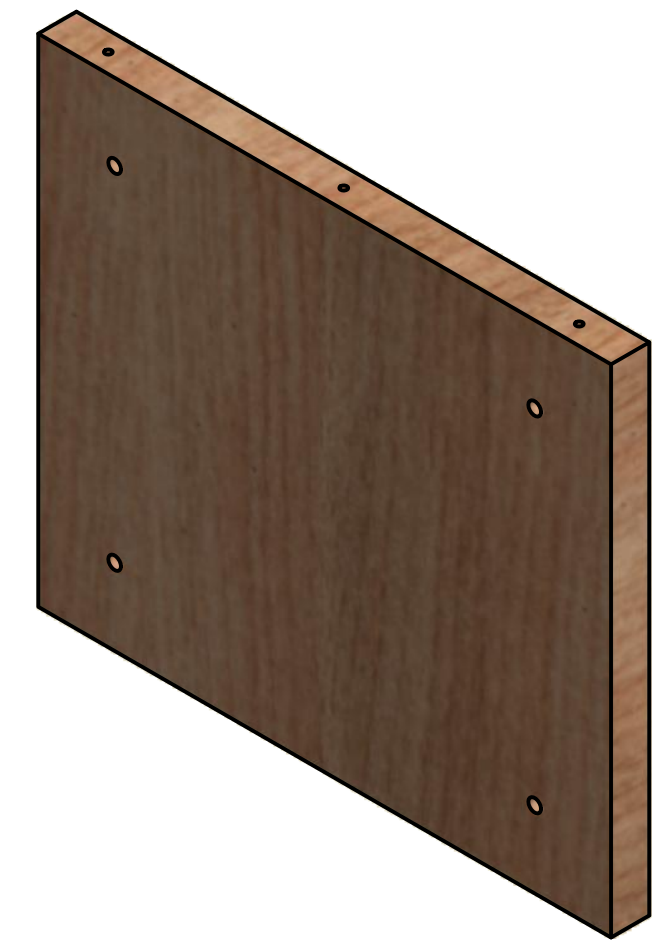
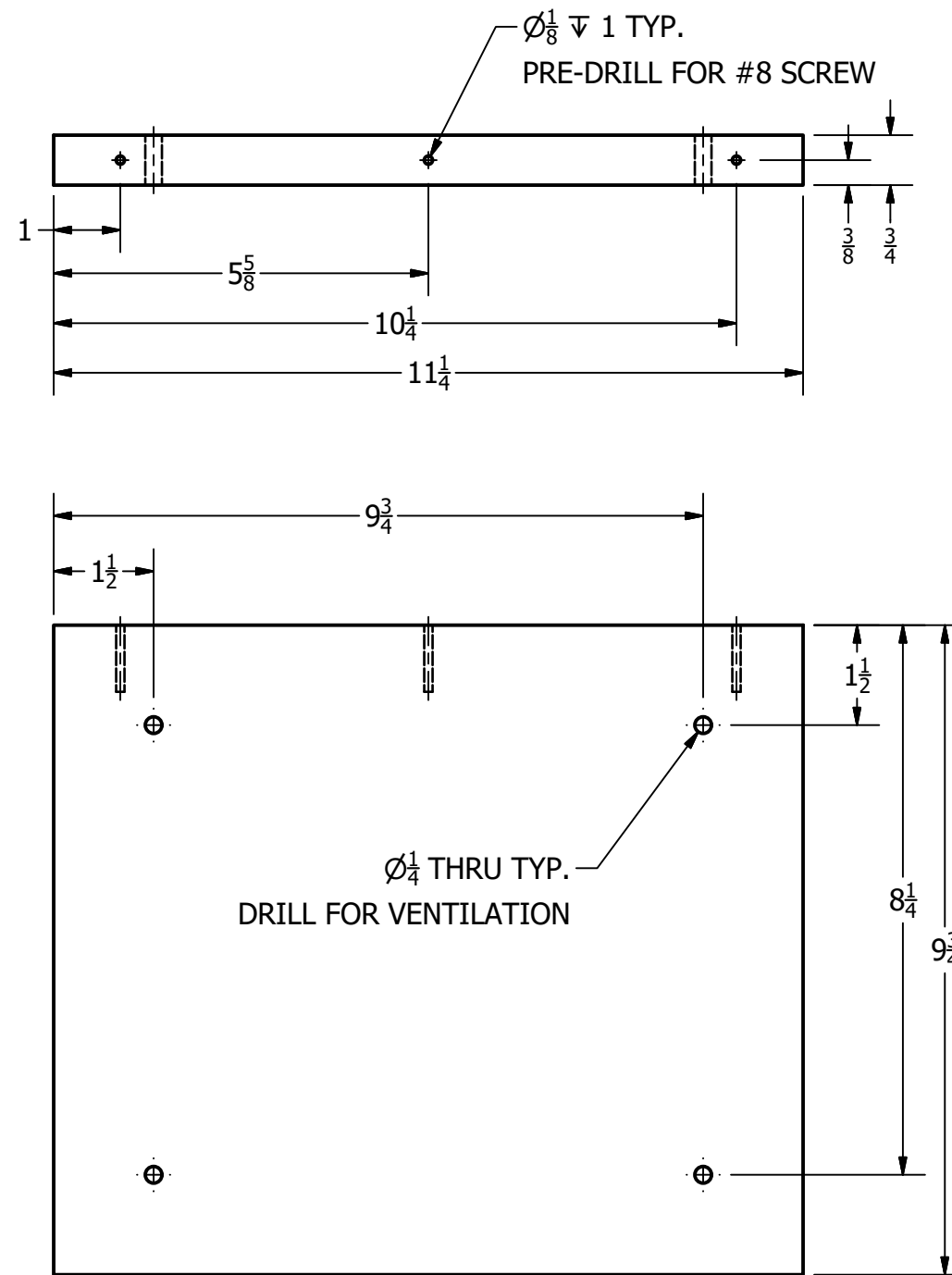

**RECOMMENDED TOOLS:**



**tea***i*

**TECHNOLOGY EDUCATION ASSOCIATION OF ILLINOIS**  
ITEC 2016-ILLINOIS DEPARTMENT OF NATURAL RESOURCES  
WILDLIFE HABITAT CONSTRUCTION SESSION

DESIGNED BY: Corey Duzan

PROJECT TITLE: Wood Duck Box Plans

9/29/2016

SHEET #

8

FILE NAME: ITEC-IDNR Wood Duck Box\_Floor.ipt

cduzan



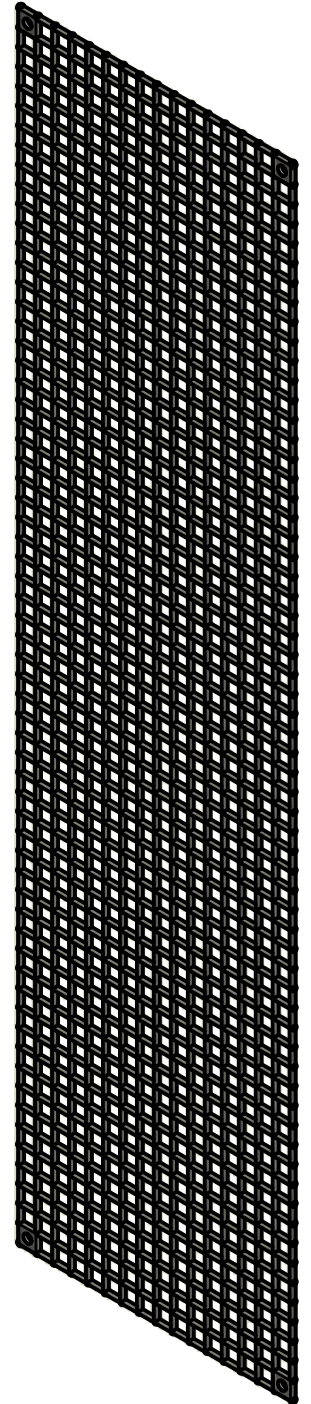
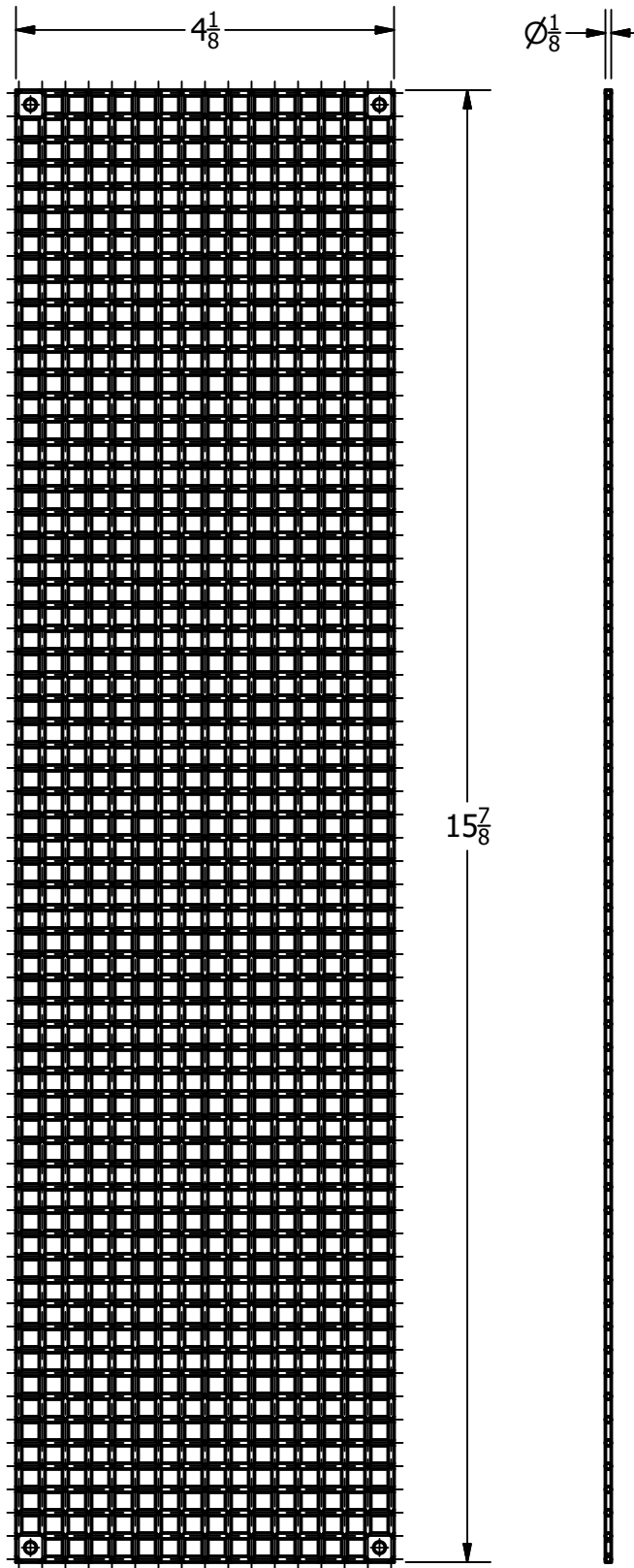

**tea***i*

**TECHNOLOGY EDUCATION ASSOCIATION OF ILLINOIS**  
 ITEC 2016-ILLINOIS DEPARTMENT OF NATURAL RESOURCES  
 WILDLIFE HABITAT CONSTRUCTION SESSION

DESIGNED BY: Corey Duzan

PROJECT TITLE: Wood Duck Box Plans

9/29/2016

SHEET # 9

FILE NAME: ITEC-IDNR Wood Duck Box\_Hardware Cloth.ipt

cduzan